

MEDM

Kenneth Evans, Jr.
August 23, 2004

Argonne National Laboratory



Office of Science
U.S. Department of Energy

*A U.S. Department of Energy
Office of Science Laboratory
Operated by The University of Chicago*



MEDM Overview

- **MEDM stands for Motif Editor and Display Manager**
- **It is a graphical user interface (GUI) for designing and implementing control screens, also called displays**
- **It is a mature program**
 - Robust
 - Powerful
 - Efficient
- **Tens of thousands of screens have been designed for MEDM**
- **It is used worldwide at many sites**
- **It is the primary means by which operators and engineers control the APS and its subsystems**
 - And most of the experiments



It is what you see in the Control Room



Example MEDM Screens

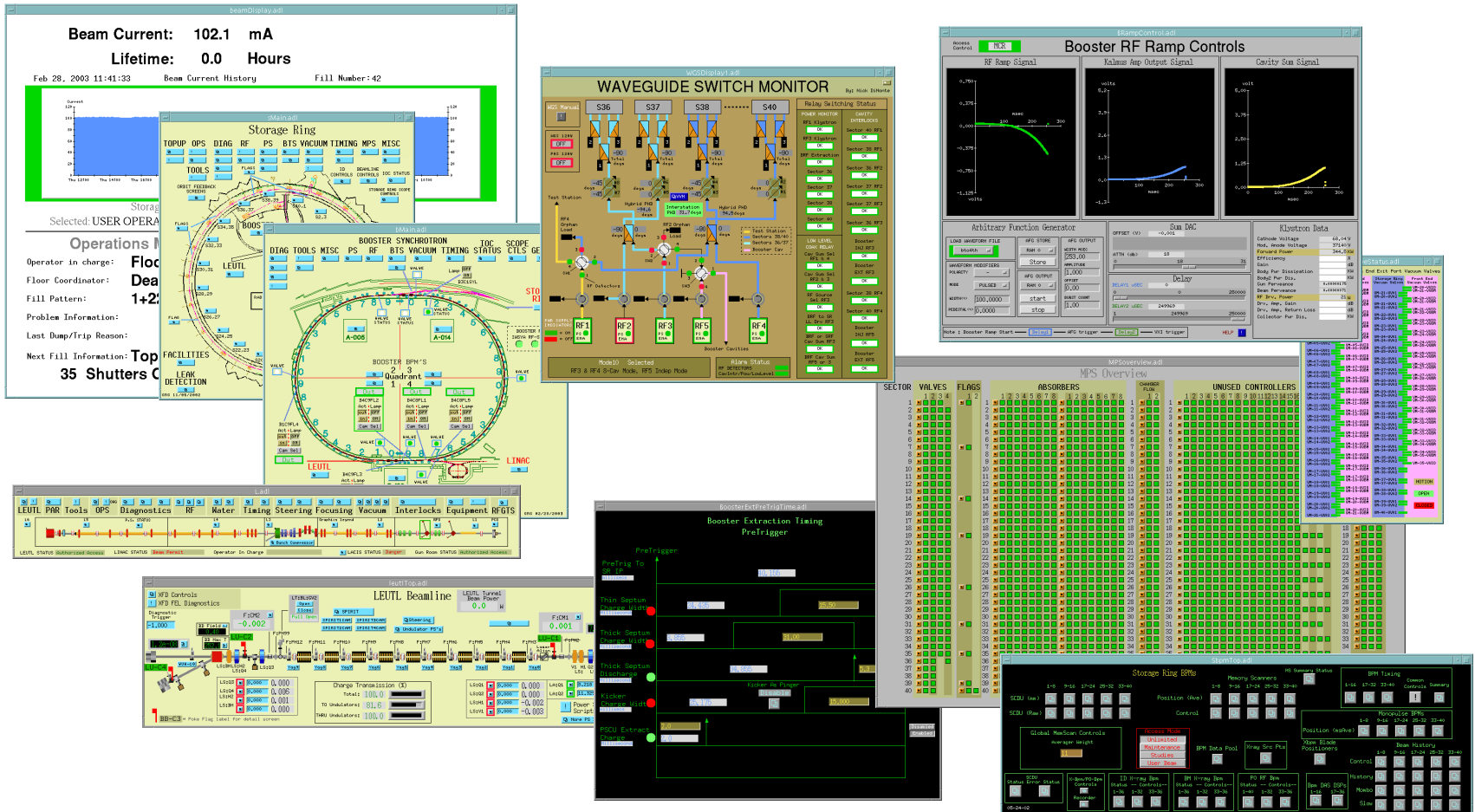

- And thousands of others

History

- **It is an APS product**
- **Started by Mark Anderson in 1990**
 - Responsible for the look and feel, much of the implementation
 - Based on DM and EDD written at Los Alamos
 - Choose Motif for a more impressive interface
- **Taken over by Fred Vong from Fall 1994 to Winter 1996**
 - Improved the performance under load
 - Rewrote the Strip Chart
 - Many of his improvements were unfinished when he left
- **Taken over by Ken Evans in 1996**
 - Concentrated on robustness, stability
 - Added most of the Editing features (Undo, Align, etc.)
 - Made Composite object be dynamic
 - Added animated GIFs, many other features



MEDM Design Philosophy

- **Performance, robustness, and maintainability come first**
 - KISS [Keep It Simple Stupid] tends to work well
- **Features are important but feature bloat is incommensurate with robustness and maintainability**
- **MEDM tries to strike a balance**
 - Robustness and maintainability come first
- **MEDM tries to enable, not restrict, the user**
 - You are responsible for not shooting yourself in the foot
- **Extensibility is best added with additional applications**
 - ADT is a good example
 - As are all the Tcl/Tk apps at the APS
 - If these crash or use resources, they do not affect MEDM
 - MEDM can do the few things it does rapidly and efficiently
 - This philosophy has worked out well at the APS



More Information

- **There is far more to MEDM than can be covered in this presentation**
- **The main source of information is the MEDM Reference Manual**
 - Can be accessed from the Help Menu
 - *Uses your browser to display HTML help*
 - *Netscape on UNIX may take a long time to come up*
 - Also available as a Word document, Postscript, and PDF
- **There is an MEDM web page**
 - <http://www.aps.anl.gov/epics/extensions/medm/index.php>
 - Has the Reference Manual and tar files of recent versions
 - Can be found from the EPICS home page
<http://www.aps.anl.gov/epics/index.php>
- **MEDM for Windows is in the EPICS WIN32 Extensions**
 - See the MEDM web page



MEDM Virtual Linac Screen

- The Virtual Linac MEDM screen is a good example to explore

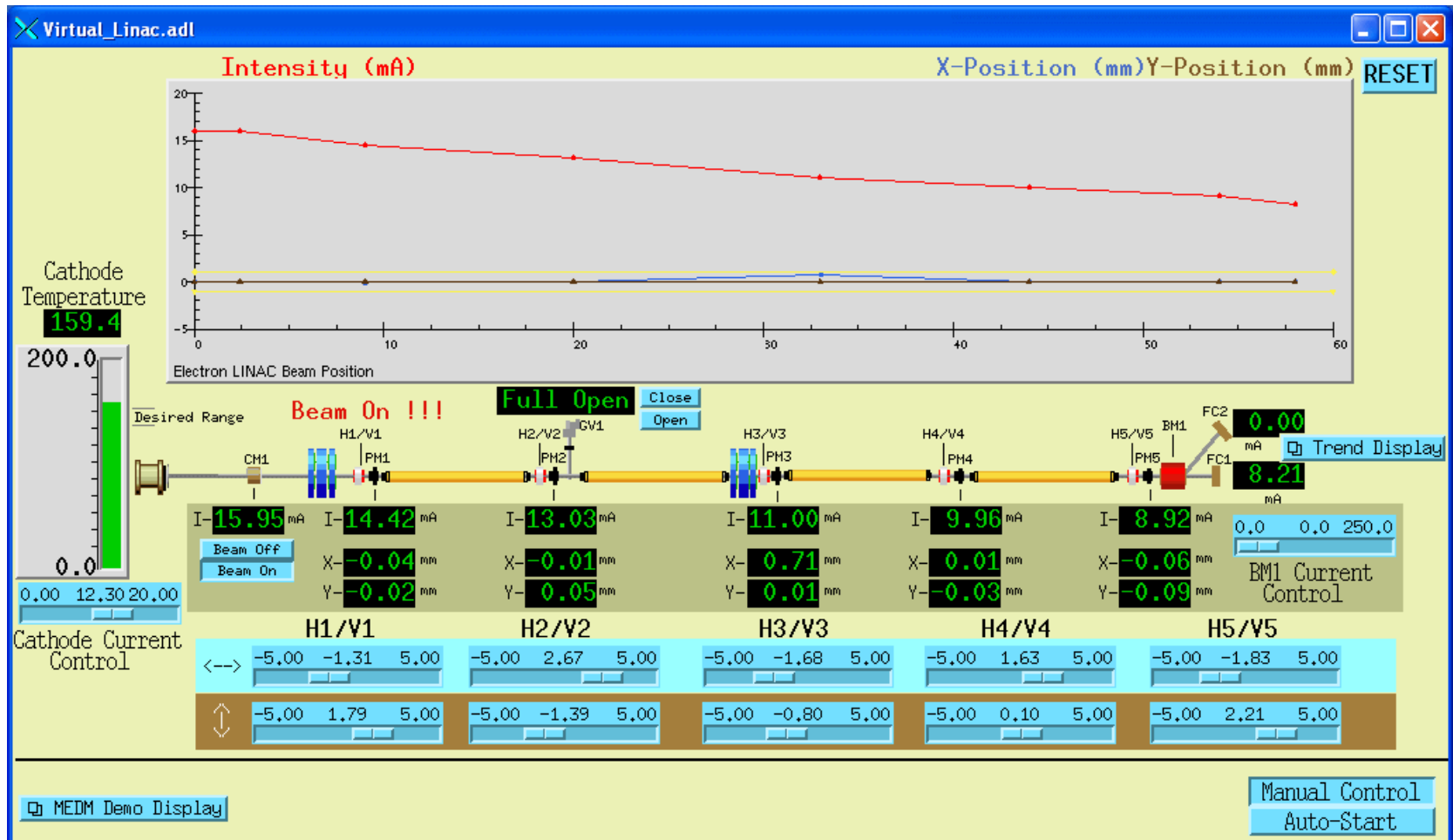

Flash Demos

- **The demos in this presentation use Flash**
- **If you do not see the demos, you do not have the Flash Player**
- **If you have trouble with the Flash demos, particularly advancing them, you may have an old Flash Player**
 - Right click on a Flash demo to see the version
 - You need Flash Player 7 or above

MEDM Main Window and Overview

Flash Demonstration of MEDM Main Window

MEDM Objects

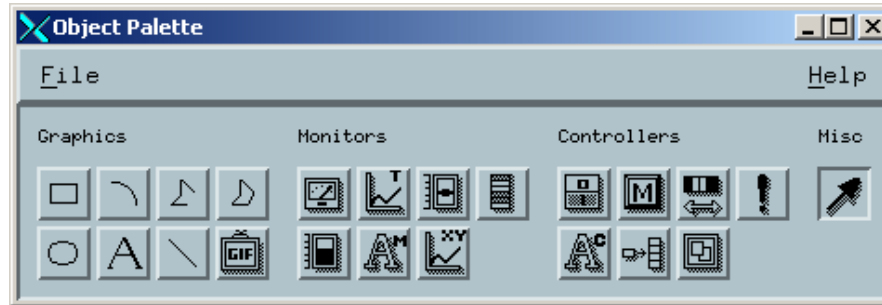

Graphics	Monitors	Controllers	Special
Arc	Bar Monitor	Choice Button	Composite
Image	Byte Monitor	Menu	Display
Line	Cartesian Plot	Message Button	
Oval	Meter	Related Display	
Polygon	Scale Monitor	Shell Command	
Polyline	Strip Chart	Slider	
Rectangle	Text Monitor	Text Entry	
Text			



Resource Palette

- Each object has a set of properties
- The properties are chosen via the Resource Palette
- All objects have
 - X and Y Position
 - Height and Width
- Others vary depending on the object
- Properties are specified by
 - Text Boxes
 - Color selectors
 - Pull down menus
 - Dialogs

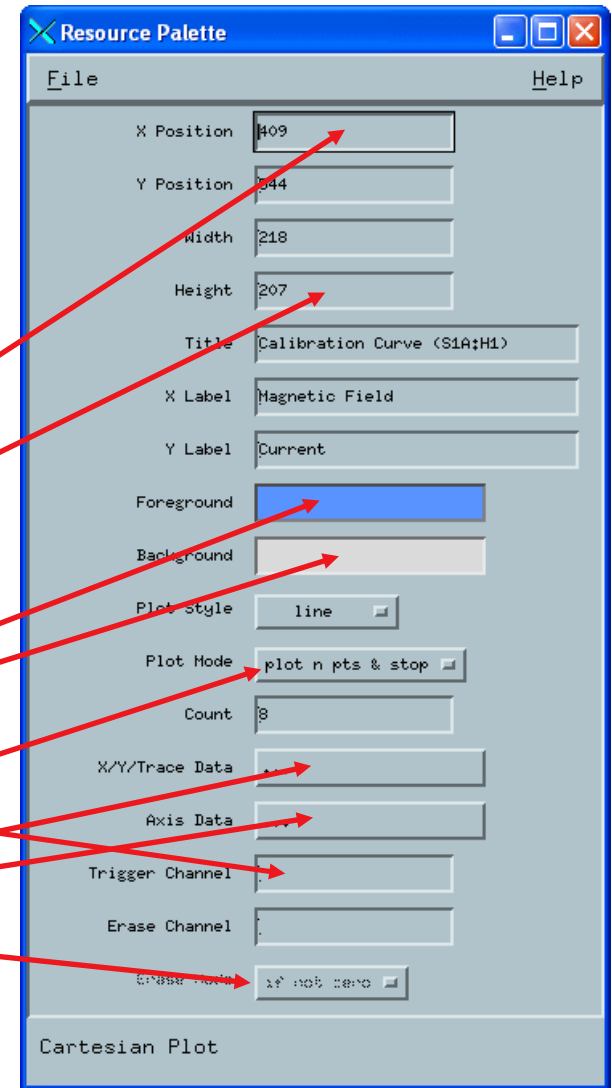

Examples of All MEDM Objects

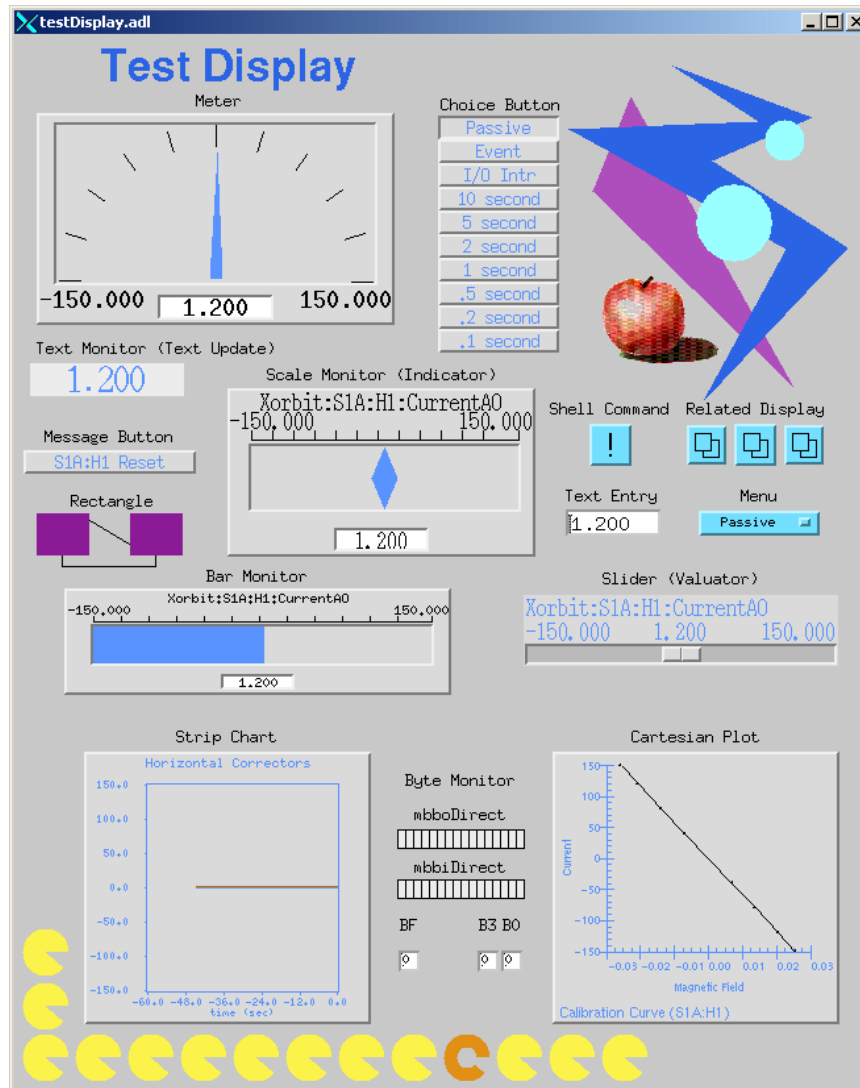

Editing Features

- **Menus are all Tear-Off**
- **Undo and Redo**
- **Align**
 - Left, Horizontal Center, Right
 - Top, Vertical Center, Bottom
 - Position to Grid
 - Edges to Grid
- **Space Evenly**
 - Horizontal and Vertical
 - 2-D
- **Grid**
 - Toggle Show Grid
 - Toggle Snap to Grid
 - Set Grid Spacing

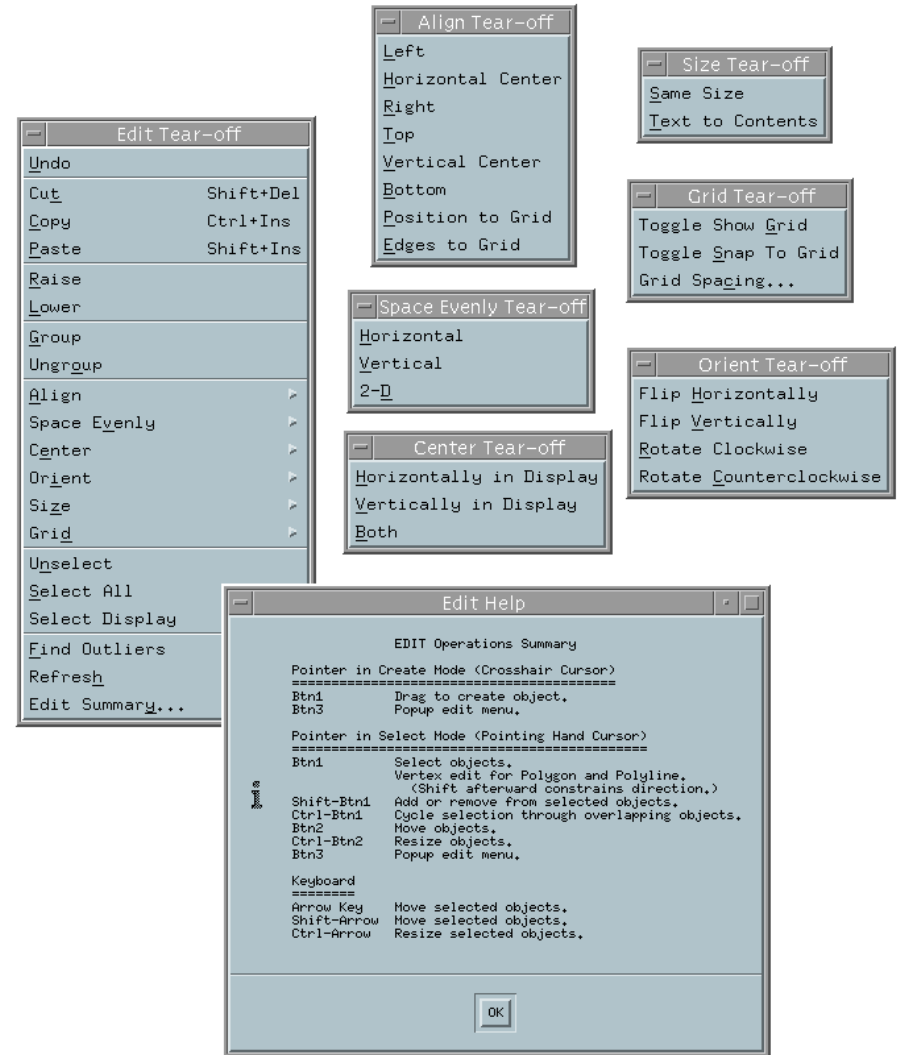

Editing Features

- **Center**
 - Horizontally and Vertically in Display
 - Both
- **Orient**
 - Flip Horizontally and Vertically
 - Rotate Clockwise and Counterclockwise
- **Size**
 - Same Size
 - Text to Contents
- **Others**
 - Find Outliers
 - Refresh
- **Edit Summary (Keyboard and Button Shortcuts)**

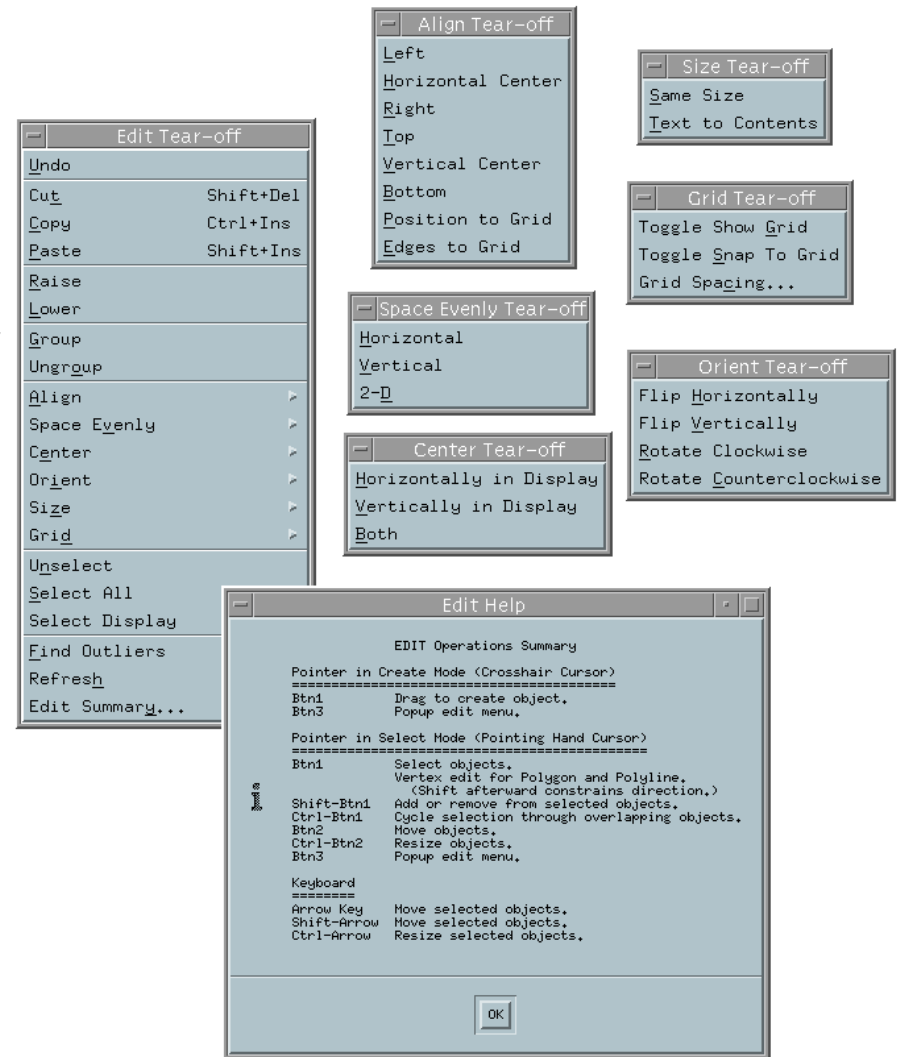

Creating a Display Screen

Flash Demonstration of Display Editing



Fonts

- **Fonts in MEDM are somewhat brain dead**
 - Changing them would trash thousands of existing screens
- **MEDM can use either Fixed or Scalable fonts**
- **Fixed fonts use font aliases for flexibility**
 - widgetDM_4, widgetDM_6, ... ,widgetDM_60
 - These can be assigned to any X Windows Font
 - We are stuck with the original APS assignments
- **Scalar fonts use one font (your choice) and vary the size**
 - Was not available when the APS was started
- **For new sites, the defaults can be changed in siteSpecific.h**
 - When MEDM is built
- **The font size is determined by the **height** of the text box**
 - The text can extend beyond the box horizontally
 - In practice you vary it until it looks right



Default Fixed and Scalable Fonts

- fontTable.adl opened without and with `-displayFont` scalable

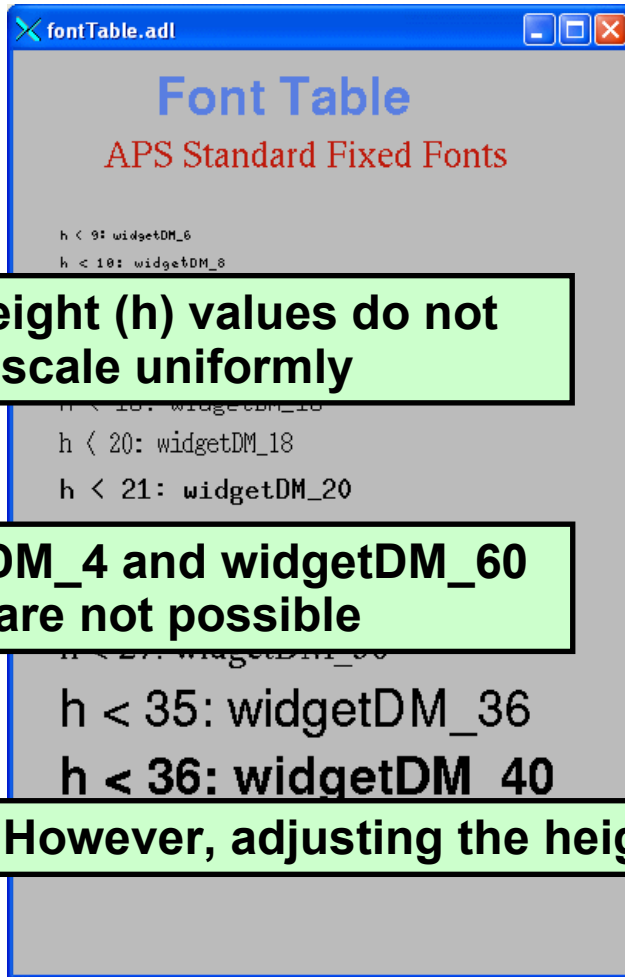

```
Font Table
APS Standard Fixed Fonts

h < 9: widgetDM_6
h < 10: widgetDM_8

h < 18: widgetDM_18
h < 20: widgetDM_18
h < 21: widgetDM_20

h < 27: widgetDM_30
h < 35: widgetDM_36
h < 36: widgetDM_40
```

The height (h) values do not scale uniformly

widgetDM_4 and widgetDM_60 are not possible

However, adjusting the height until it looks right works OK

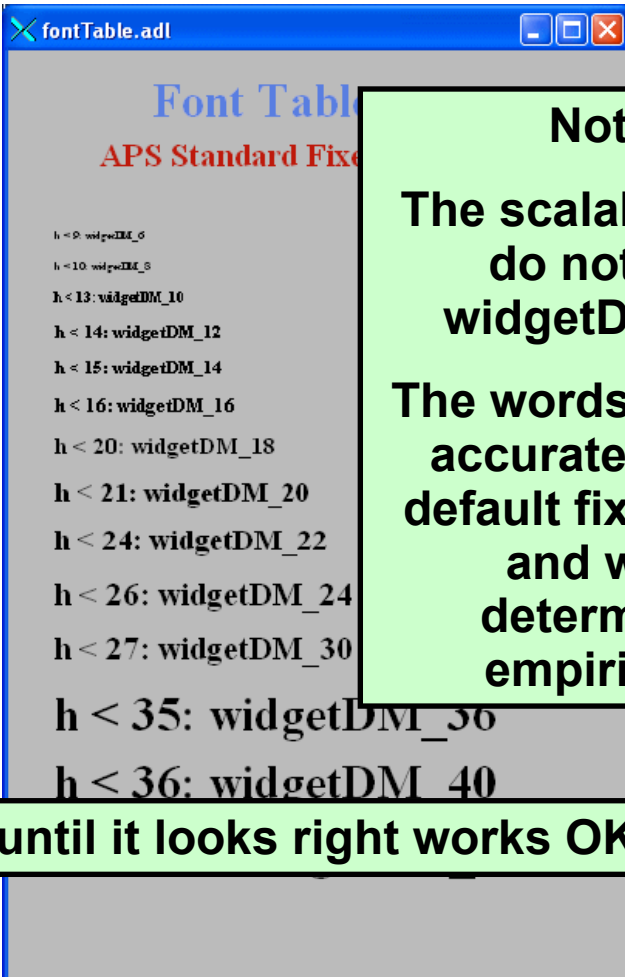

```
Font Table
APS Standard Fixed Fonts

h < 9: widgetDM_6
h < 10: widgetDM_8

h < 13: widgetDM_10
h < 14: widgetDM_12
h < 15: widgetDM_14
h < 16: widgetDM_16

h < 20: widgetDM_18
h < 21: widgetDM_20
h < 24: widgetDM_22
h < 26: widgetDM_24
h < 27: widgetDM_30

h < 35: widgetDM_36
h < 36: widgetDM_40
```

Note:
The scalable fonts do not use widgetDM_xxx
The words are only accurate for the default fixed fonts and were determined empirically

siteSpecific.h

- **Many of the MEDM default choices are in siteSpecific.h**
 - C language header file
 - Used when MEDM is compiled
- **Sites can change these defaults by changing this one file**
- **Some of the things that can be changed**
 - Fixed or Scalable fonts
 - Colors
 - Location of the HTML Reference Manual
 - Printer defaults
 - Others
- **Decisions must be made early before many screens are designed**

Graphic Objects

- Many effects are created with Graphics objects

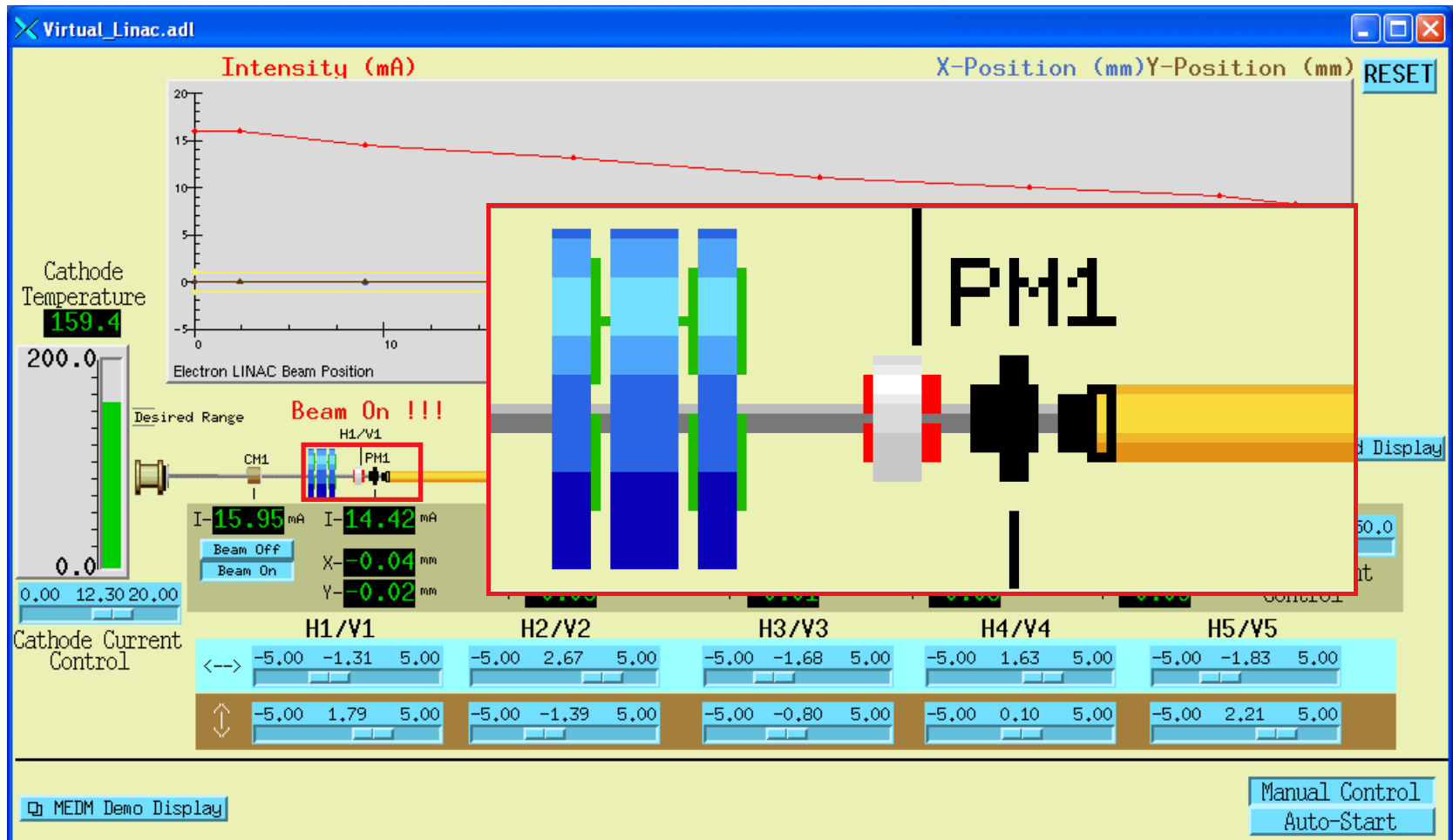

Dynamic Attribute

- **Applies primarily to Graphics objects**
- **Objects with a Dynamic Attribute can have their color or visibility change based on process variables or conditions**
- **Color Mode**
 - Object has alarm colors (Green, Yellow, Red, White)
- **Visibility Mode**
 - Visible only if the process variable is zero or only if not zero
- **Visibility Calc Mode**
 - Visibility is based on a CALC expression involving up to 4 process variables plus HOPR, LOPR, STAT, SEVR, etc.
- **Also applies to the Composite**
 - Allows whole sections of the display to appear or disappear
 - Means any object can have a Dynamic Attribute
 - *Make it be a Composite with just one member*

CALC in MEDM

- **Used in two places**
- **Visibility**
 - Used when Visibility mode is set to “calc” and Visibility Calc is defined
 - CALC expression returns True or False
 - The APS Status Display uses this feature
 - *With Composites (like the Demo)*
- **Image Frame Number (Animated GIFs)**
 - Used when Image Calc is defined
 - Will just animate otherwise
 - CALC expression returns a frame number
 - Frame numbers start with 0
 - Uses 0 or last frame if out of range

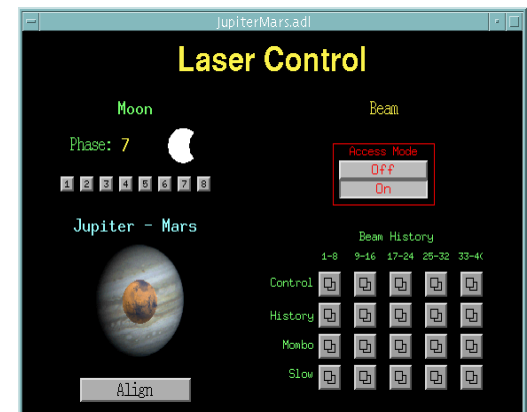
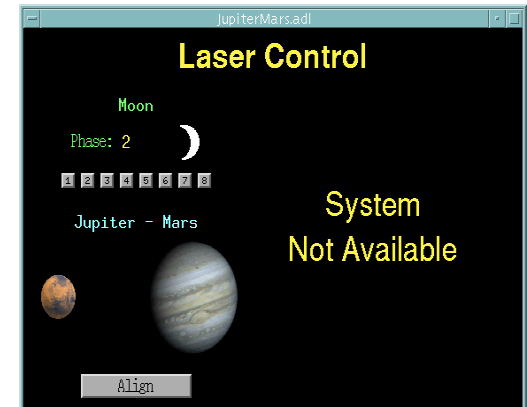

Visibility Demo

Flash Demonstration of Dynamic Attributes

MEDM CALC Expression

- **Expression involving 16 variables**

- A The value of Channel A
- B The value of Channel B
- C The value of Channel C
- D The value of Channel D
- E Reserved
- F Reserved
- G The COUNT of Channel A
- H The HOPR of Channel A
- I The STATUS of Channel A
- J The SEVERITY of Channel A
- K The PRECISION of Channel A
- L The LOPR of Channel A

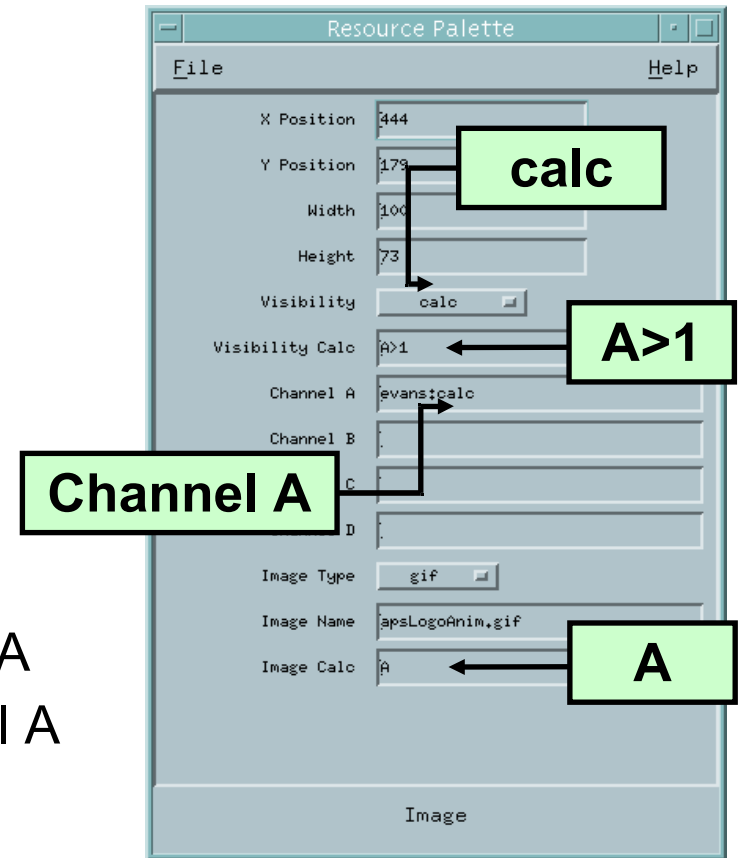

Examples of MEDM CALC Expressions

- **Syntax is the same as for the EPICS CALC record**
 - See the Record Reference Manual
- **Some True/False Examples (for Visibility)**
 - !A Value is zero (Same as "if zero")
 - A Value not zero (Same as "if not zero")
 - A=12 Value is 12
 - A#12 Value is not 12
 - A<0&&B<0&&C<0 All are negative
 - A>.9*H Beyond 90% of upper limit
 - !J SEVERITY is not zero
- **Some Number Examples (for Image Calc)**
 - A Frame is value of A
 - A=12 Frame 0 or 1
 - (A+B)*SIN(C) Frame determined by expression

Alarm

Color Rules Using Animated GIFs

- **Make a multi-frame GIF**
 - One frame per desired color, One pixel per frame
- **Put this GIF under the object you want to have color rules**
- **Use a CALC expression that rounds off to the frame number**
- **Example: 3 colors: Green, Yellow, Red**
 - **CALC:** $(ABS(A) < .8 * H) + (ABS(A) < .9 * H)$
 - **Gives:** Green for $|A|$ up to $0.8 * HOPR$
Yellow for $|A|$ from $0.8 * HOPR$ to $0.9 * HOPR$
Red for $|A|$ greater than $0.9 * HOPR$

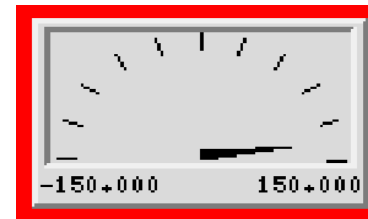
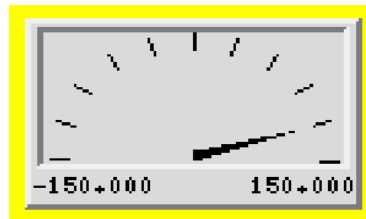
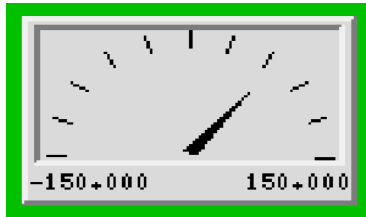

Use SGA to Make and Edit Animated GIFs

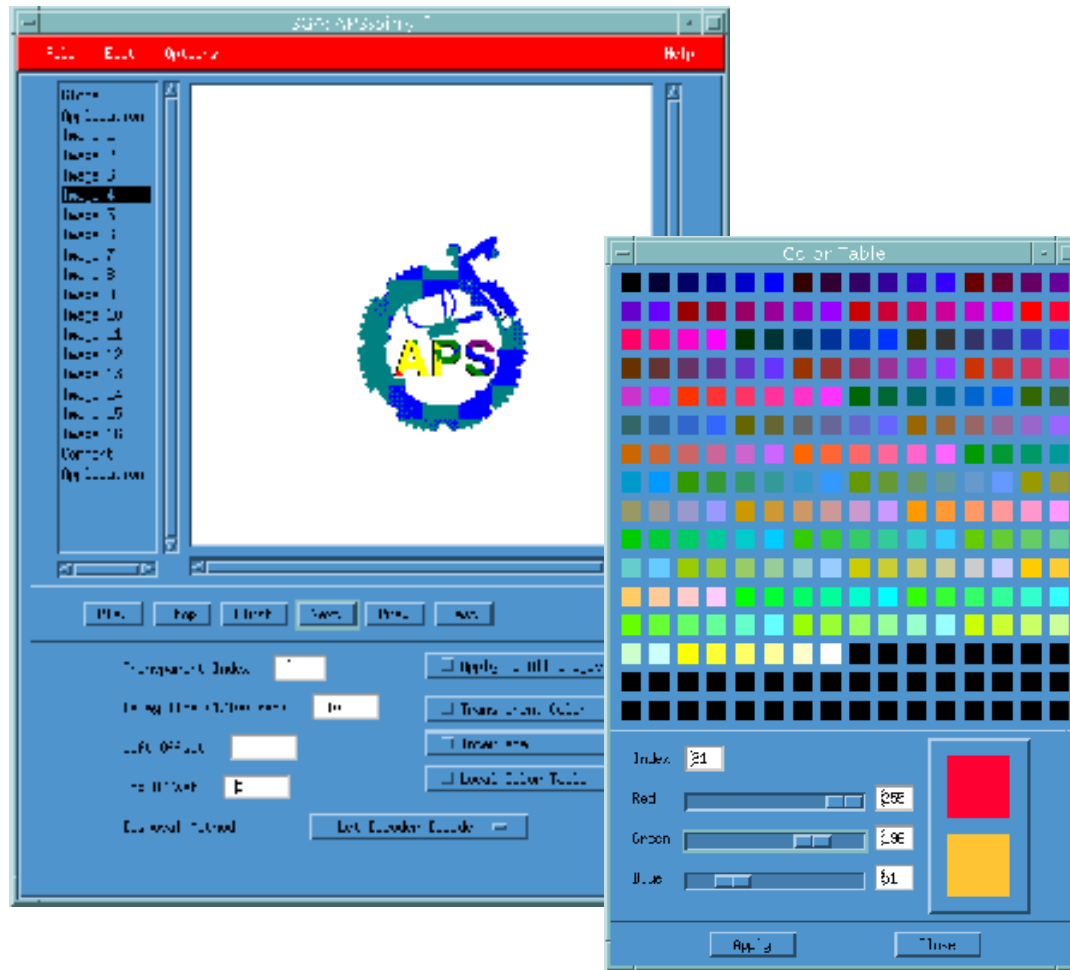

Execute Mode

- What's wrong with this screen?

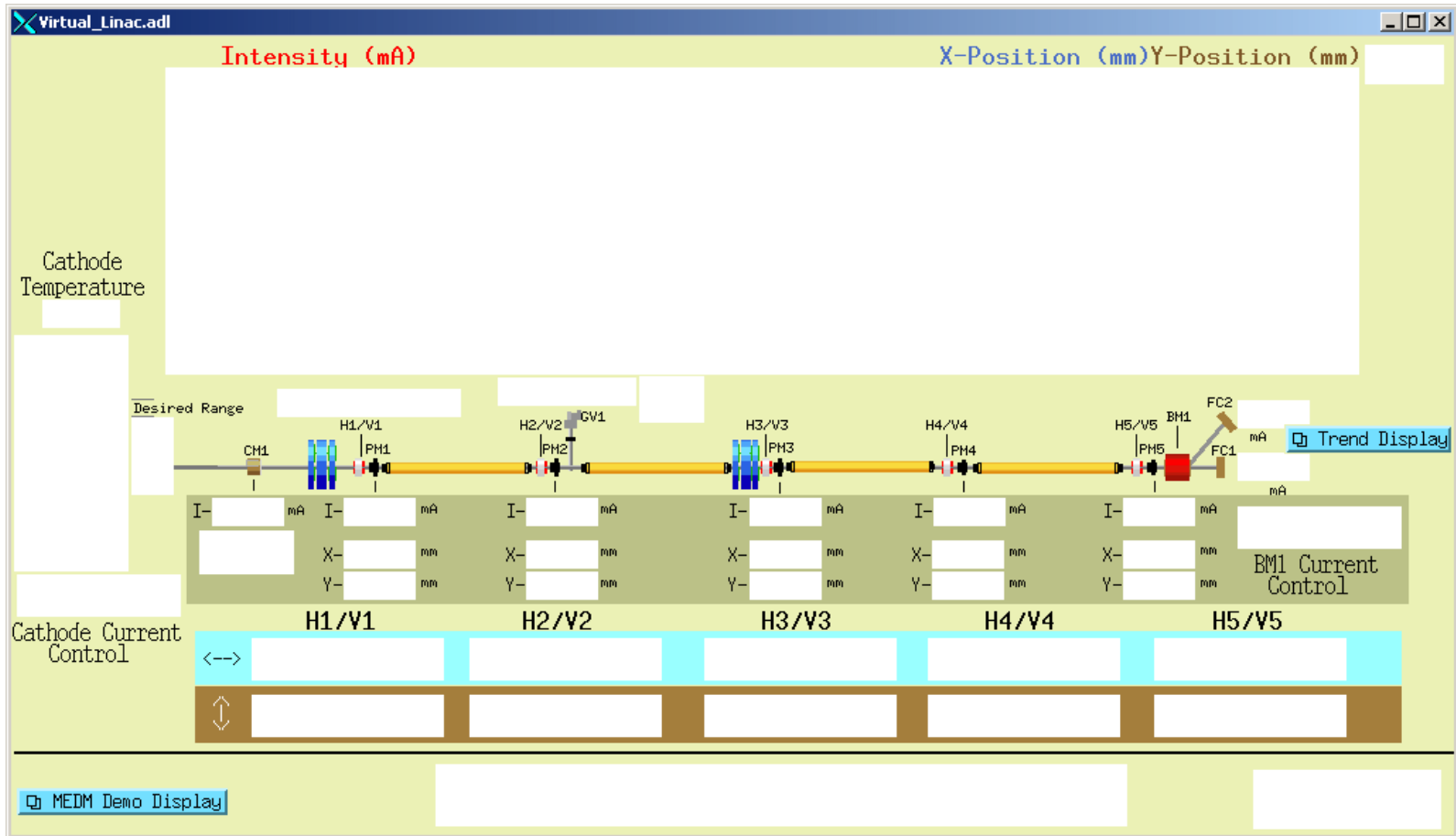

- MEDM objects turn white when the connection is lost

Drag and Drop

- **You can drag the process variable names from an object**
 - Use Mouse Button 2
- **The Process variable name appears in its alarm color on black**
- **Can be dragged to any Motif Drop Site**
 - This includes Probe, StripTool, HistTool, and others
- **Names now go into the X Clipboard as well**
 - Can paste them in the usual places without even dragging
- **In practice Button 2 is used as a fast way to see the process variable name**



PV Info

- **PV Info**
 - Gives extensive information about the process variable
- **Accessed through the Execute-Mode Menu**
 - Right click the display
 - Use the cursor to pick which object

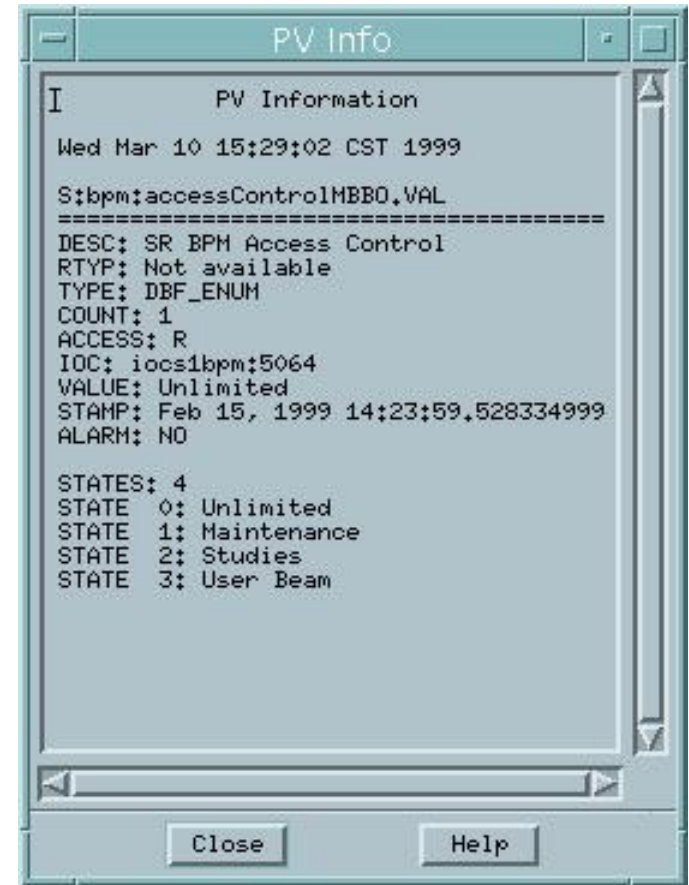

PV Limits

- **PV Limits**
 - Allows you to set the limits for Meters, Sliders, etc
- **The user can:**
 - Use the values from Channel Access (HOPR, LOPR, PREC)
 - Use the defaults set by the screen designer
 - Set her own values
- **The screen designer can:**
 - Set it to use Channel Access values for the defaults
 - Set the defaults
- **Accessed through the Execute-Mode Menu**

The screenshot shows a dialog box titled "PV Limits" for the parameter "S1:C:feedback1SetPt0". It is divided into three sections:

- Low Limit (LOPR):** The "Source" is set to "Channel" and the "Value" is "-10".
- High Limit (HOPR):** The "Source" is set to "User Specified" and the "Value" is "5".
- Precision (PREC):** The "Source" is set to "Default" and the "Value" is "0".

At the bottom of the dialog, there are two buttons: "Close" and "Help".

Execute Menu

- The Execute Menu is a user-configurable menu that can be added to the right-click menu on displays in Execute Mode
- Specified by the MEDM_EXEC_LIST environment variable
 - If not specified, it doesn't appear at all
- Example
 - `setenv MEDM_EXEC_LIST 'Probe;probe &P &: ADL File;echo &A:PV Name(s);echo &P'`
 - Gives the menu shown
 - Selecting the Probe item, for example, will allow you to select an object, then run Probe on its process variable
- See the manual for details

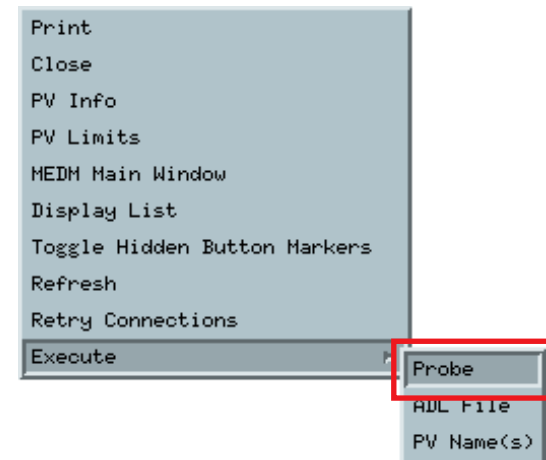

Macros

- **Strings of the form \$(name) in an ADL file can be replaced by some other string**
 - For example, enter \$(sector):\$(corrector) as part of a PV name
- **Replacement is specified:**
 - 1. On command line:

```
medm -x -macro "sector=S1A,corrector=H2"
```
 - 2. In Related Display configuration:
Resource Palette dialog
- **Allows you to design one screen and use it for many similar items**
- **The Virtual Linac uses \$(user) in front of PV names**
 - So different users have their own PV names
 - Look at the startup scripts for MEDM for the Virtual Linac

Related Display

- Brings up a menu of other displays
- As with most MEDM objects there are many options

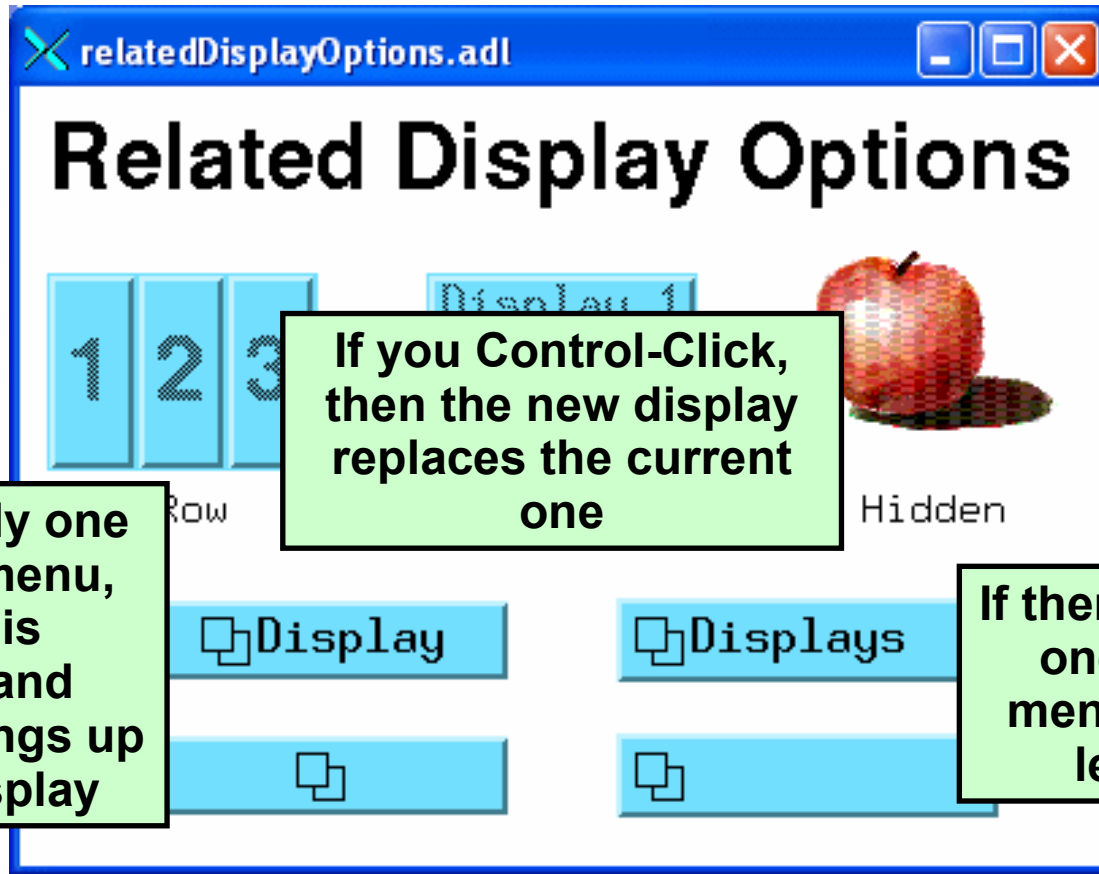

If there is only one item in the menu, the label is centered, and clicking it brings up that one display

If you Control-Click, then the new display replaces the current one

If there is more than one item in the menu, the label is left justified

Bar Monitor

- Here are some options for the Bar Monitor

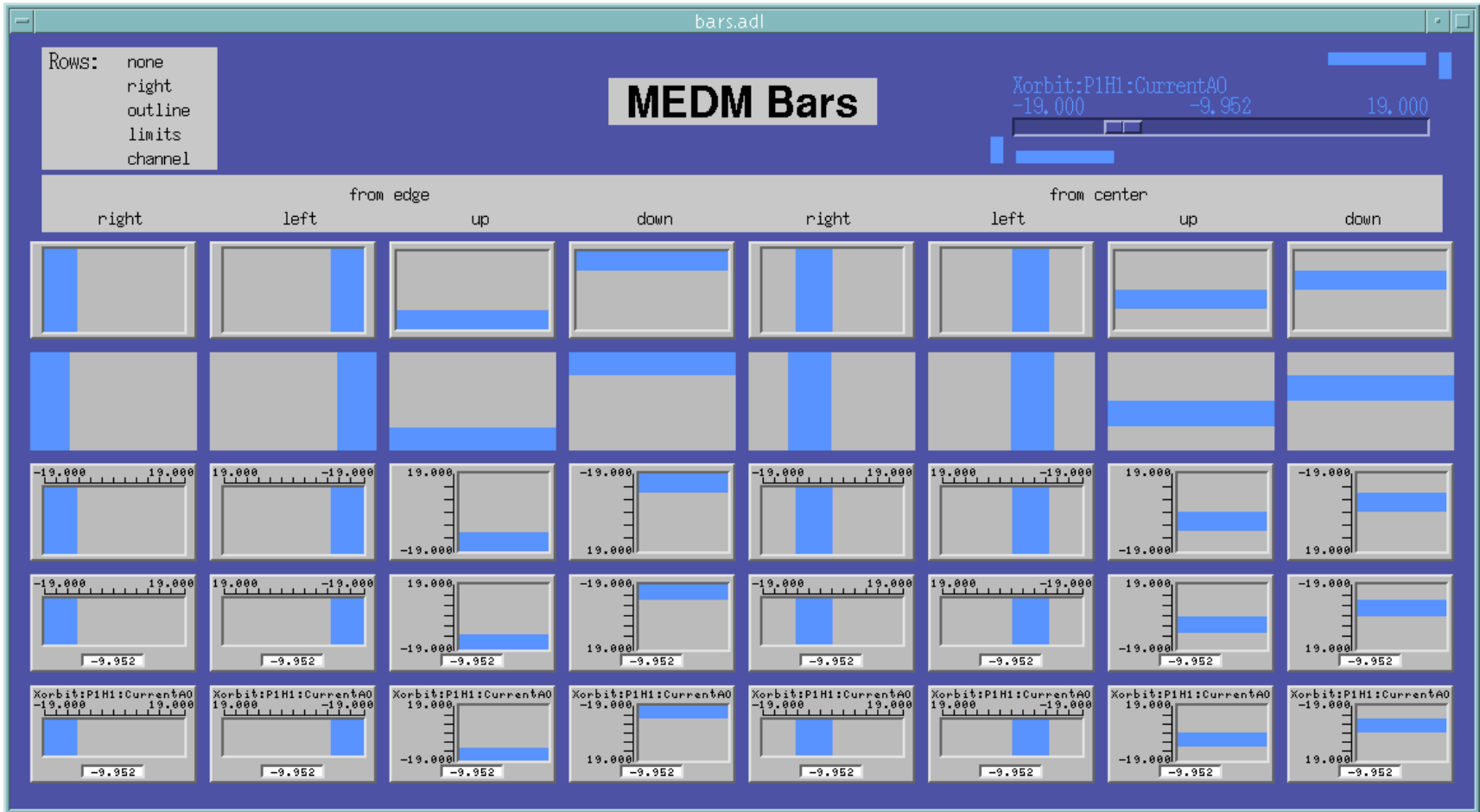

Bar Monitor

- The no decorations mode, useful for bar graphs and effects

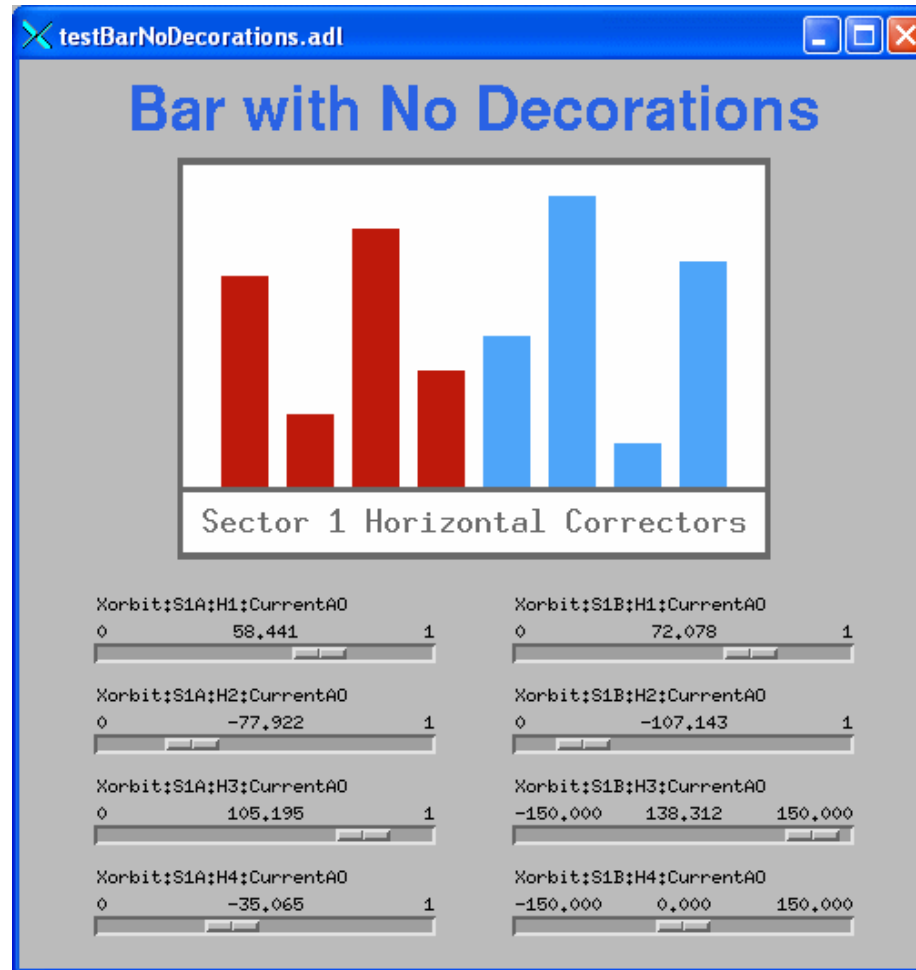

Strip Chart

- While not as powerful as StripTool, the MEDM Strip Chart has many features, which can be changed on the fly

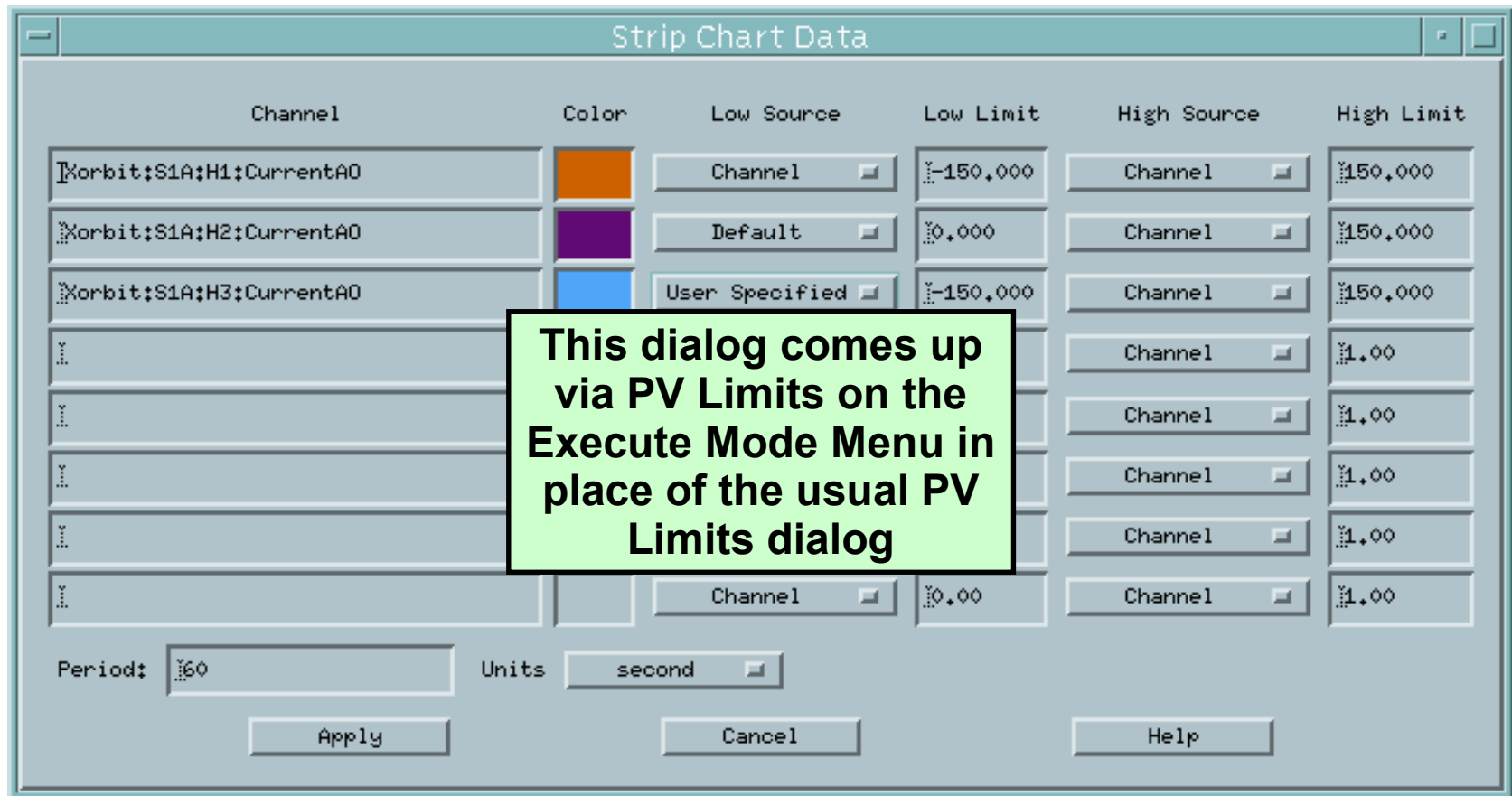

Cartesian Plot

- **The Cartesian Plot is the most complicated MEDM object**
- **MEDM provides generic support for different plot packages**
- **XRT/Graph**
 - Most complete implementation is XRT/Graph
 - Commercial product, not available for Windows
 - Requires a license on each machine on which it is built
 - Many features and works well
- **SciPlot**
 - Public Domain, modified extensively for MEDM
 - Included with MEDM, should work on any platform
 - Currently missing Second Y axis and Fill Under
- **JPT**
 - Developed at TJNAF
 - Does not support all MEDM Cartesian Plot features

Summary

- **MEDM is a full featured, mature, robust program**
- **It is the principal means by which humans control the system**
- **This has been an overview of some of the MEDM features**
 - There are many more
 - The Reference Manual is the best source of information