

Creating IOC Databases

Andrew Johnson (AES/SSG, Argonne)

Includes material from:

Nick DiMonte (AES/CTL, Argonne)

Outline

- Purpose
- Tools available
- VisualDCT
- Creating a Database
- Creating Records
- Property Inspector
- Creating links
- Macros
- Hierarchical Design

How to Create a Database

- Databases are just ASCII text files, what's wrong with just doing this?

```
$ echo 'record(bi, "anj:bi1") {}' > test.db  
$ vi test.db
```



Reminder: DBD & DB Files

```
menu(aoOIF) {
  choice(aoOIF_Full,"Full")
  choice(aoOIF_Incremental,"Incremental")
}
recordtype(ao) {
  include "dbCommon.dbd"
  field(VAL,DBF_DOUBLE) {
    prompt("Desired Output")
    promptgroup(GUI_OUTPUT)
    asl(ASL0)
    pp(TRUE)
  }
  ...
  field(OIF,DBF_MENU) {
    prompt("Out_Full/Incremental")
    promptgroup(GUI_OUTPUT)
    interest(1)
    menu(aoOIF)
  }
  ...
}
```

```
record(bo,"$(user):gunOnC") {
  field(DTYP,"Soft Channel")
  field(ZNAM,"Beam Off")
  field(ONAM,"Beam On")
}
record(calc,"$(user):flameM") {
  field(CALC,"A<32?A+1:0")
  field(SCAN,".1 second")
  field(INPA,"$(user):flameM.VAL NPP")
}
record(ao,"$(user):cathodeCurrentC") {
  field(DESC,"set cathode current")
  field(DTYP,"Raw Soft Channel")
  field(SCAN,"1 second")
  field(OIF,"Full")
  field(PREC,"2")
  field(EGU,"Amps")
  field(DRVH,"20")
  field(DRVL,"0")
  field(HOPR,"20")
  field(LOPR,"0")
}
```

The highlighted parts of the DB file must match entries in the IOC's DBD file

Problems with using a Text Editor

- Content must follow complicated rules
- User must know or look up which fields are available in each record type and the correct choice strings for each menu field
 - Each IOC may have a different set of record types and menu choices
 - Fixing typo's is not efficient use of engineers time
- A text editor doesn't let you see more than a few records at once
 - It can't provide an overview of the database
 - Doesn't show connections between records (links)



Database Configuration Tools

- Database Configuration Tools (DCTs) help avoid mistakes
 - Show what design fields a record type provides
 - Present a list of valid choices for field values
 - Enforce correctness of syntax and content
 - Hide details (fields) that don't matter
- Newer ones provide a graphical view of the database
 - `assert(worth(picture) == worth(words << 10));`

History of EPICS DCTs

- DCT — Database Configuration Tool
 - Text-mode (curses) interface, provided with very old versions of EPICS Base
 - Solves the record types/fields/choices/file syntax problems
 - No graphical view of the database
- DCT in Tcl/Tk, JCDT — Java Database Configuration Tool
 - GUI Forms views of individual records, like the original DCT
 - Still no graphical view of the database
- GDCT — Graphical Database Configuration Tool
 - Flat graphical view of database records and field settings
 - No hierarchy, so not suitable for large databases
- *CapFast*
 - Electronic circuit design tool from Phase 3 Logic
 - Hierarchical editor, use wires for database links
 - Program from LANL converted schematic diagrams into database files
 - Not database-aware, editor doesn't offer or check choices for menu fields

Current EPICS DCTs

- VisualDCT — Visual Database Configuration Tool
 - Written under contract by CosyLab (GPLv3)
 - Hierarchical design, graphical layout stored in .db file comments
 - Database-aware, reads DBD files
 - Creates database files directly
 - Can import non-graphical databases

- TDCT — TRIUMF Database Configuration Tool
 - Can read & write *CapFast* schematic and symbol files
 - Hierarchical design, graphical layout stored in separate .sch and .sym files
 - Database-aware, reads DBD files
 - Creates database files directly
 - Can import VDCT databases



VisualDCT Main Window

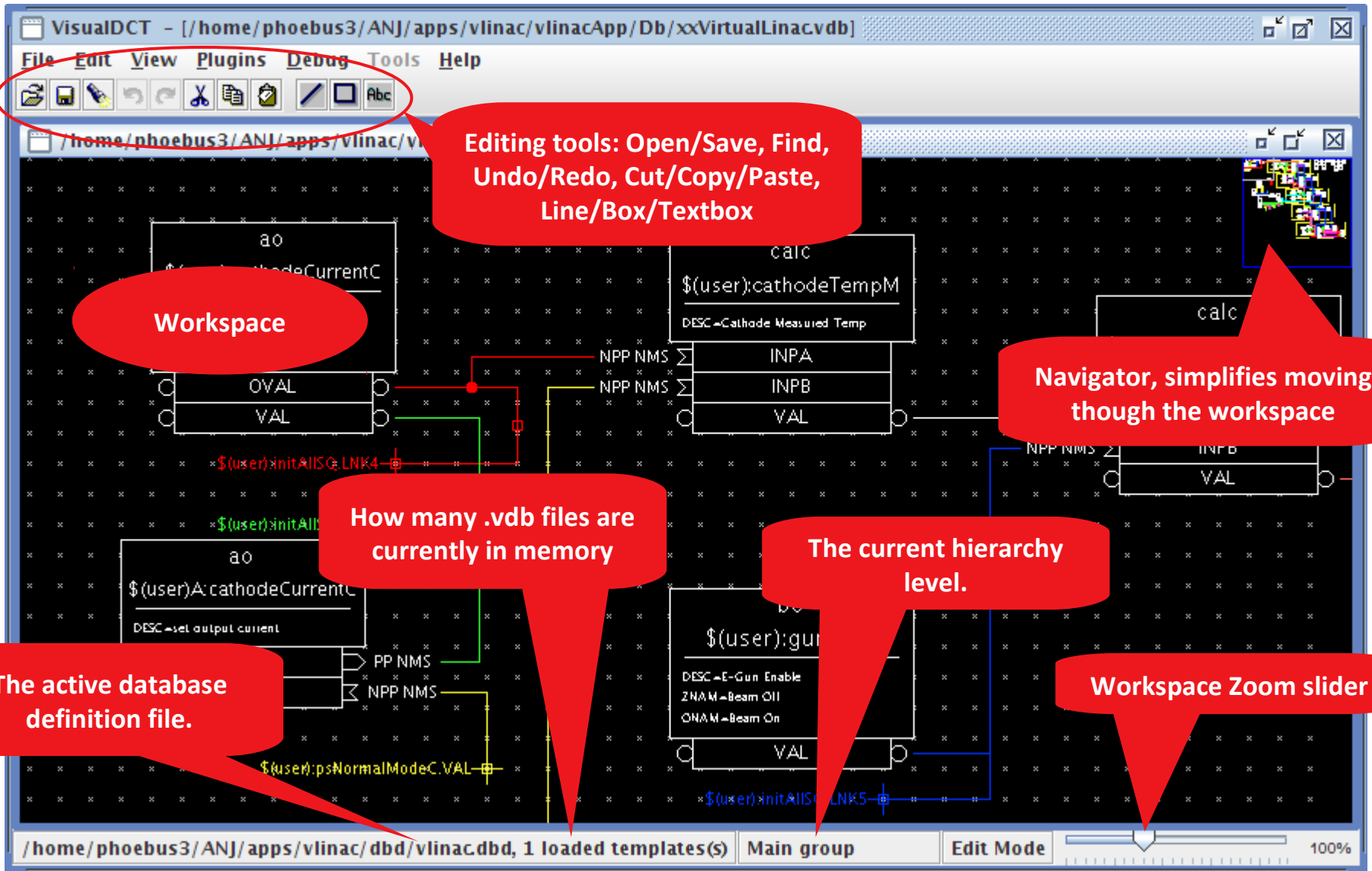

Using VisualDCT

- Type `vdct` to launch it
 - Actually a script that sets the Java Classpath and runs program
- Optional parameters for paths to a `.dbd` file and/or a `.vdb` file
 - If not given you'll be asked to select a `.dbd` file to use
 - VisualDCT's `.vdb` files usually contain the path to their `.dbd` file
- Editing diagrams uses a combination of left & right mouse-button clicks, drags and double-clicks, possibly with Shift pressed, and does different things depending on what you're pointing at and whether it's currently selected or not
 - Help tells you what mouse events it recognizes
- A `.vdb` file that doesn't use hierarchy features can be loaded directly by an IOC
 - Use 'File :: Generate' to create a flat `.db` file from a hierarchical design



Help :: Help Topics

VisualDCT - file:/net/phoebus/epics/extensions/javalib/VisualDCT2.6.1274.jar!/docs/help.html

Visual DCT Help

Mouse events

Left button double-click on blank space	New record
Left button double-click on record/field	Inspect object
Left button double-click on group	Go into group
Right button on record/field/connector	Popup menu
Left button drag on blank space holding Shift	Move desktop
Left button drag in navigator	
Left button drag over record/group	Move object/object selection
Left button click on record	Start linking
Left button click on record	Link target to VAR field
Left button click on variable field	Link target to selected field
Right button click on record	Choose variable field
Left button selection	Select objects
Right button selection	Zoom-in selection
Right button click on variable field holding Shift (with are more than one link)	Rotate link

Close

Creating a Database

- If you don't have an empty work-space, use 'File :: New'
- The file-name is set when you use 'File :: Save' or 'File :: Save as...'
 - Use the extension .vdb for VisualDCT databases
- Double-click in an empty area of the work-space to create a new record
 - Select the record type to create
 - Type in a record name
 - Press Return or click OK

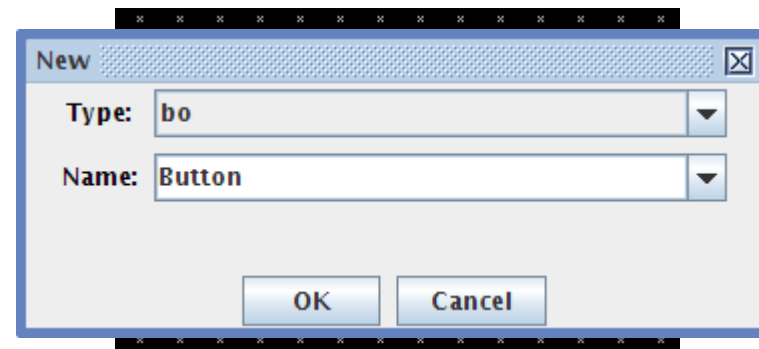

Record Symbol

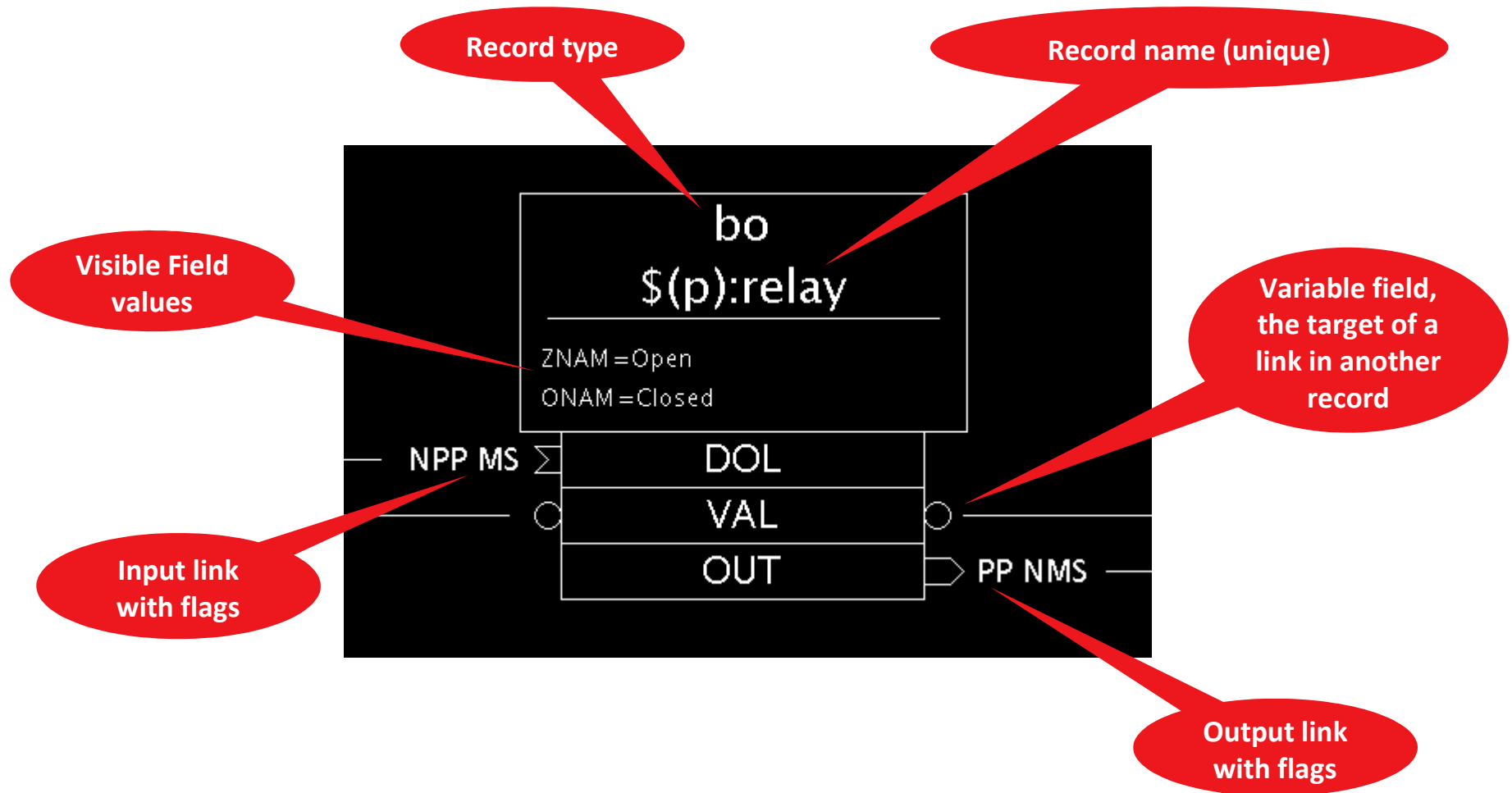

The Inspector: Examining fields

VisualDCT - [/home/phoebus3/ANJ/apps/vlinac/vlinacApp/Db/xxV...]

File Edit View Plugins Debug Tools Help

/home/phoebus3/ANJ/apps/vlinac/vlinacApp/Db/xxV...

Inspector - \$(user):cathodeCurrentC

\$(user):cathodeCurrentC (ao)

Group Alphabetical DBD Order

Value	Name
GUI_COMMON	GUI_COMMON
DESC	Cathode Current Co...
ASG	\$(user)
UDF	1
GUI_LINKS	
DTYP	Raw Soft Channel
FLNK	
GUI_INPUTS	
SIOL	
SIML	
SIMS	<none>
GUI_OUTPUT	
OROC	.05
DRVH	20
DRVL	0
VAL	

Comment

Frozen

Center object Close

Double click a record to bring up the Inspector

ao
\$(user):cathodeCurrentC
DESC=Cathode Current Control
ASG=\$(user)
DTYP=Raw Soft Channel

DESC=CM1 Intensity

INPA
INPB
VAL

PP NMS
NPP NMS

\$(user):psNormalModeC.VAL

/home/phoebus3/ANJ/apps/vlinac/dbd/vlinac.dbd, 1 load

100%

Editing field values

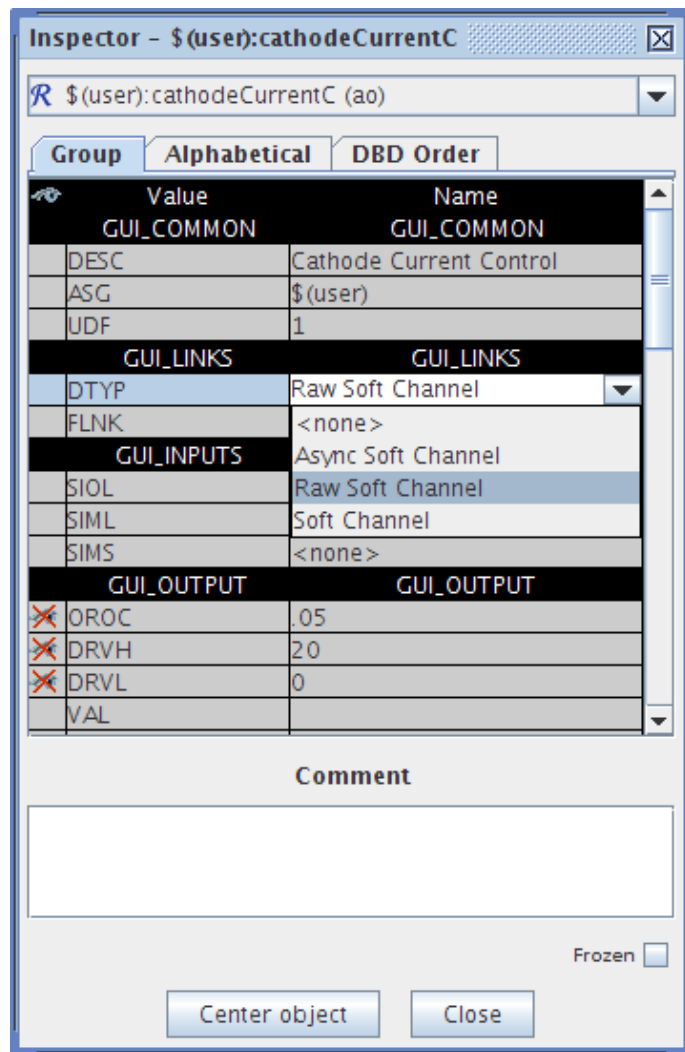

- Tabs alter the field order shown
- Click in the right column of a row to edit that field value
 - Menu fields will offer a list of valid choices for selection
- The left column controls visibility of fields in the work-space
 - Normally only fields with non-default values are shown
 - Click to change: Show always, Never
- Switch to a different record by clicking the record name pull-down, or just double-click on it in the work-space

Setting link fields

- Right-clicking on a record brings up a menu with various options
- Select the link field you want to set under INLINK, OUTLINK or FWDLINK
 - The record starts flashing red
- Now find and click on the target record
 - Left-click selects the default (VAL) field
 - Right-click lets you select any other field (pick the VARIABLE menu item, then use MORE as needed to reach the field)
- The link appears with a line to its target
 - Set PP/MS by right-clicking on the link
- Use the 'Add Connector' link menu item as needed to move the line around; this link needed 2 connectors

VisualDCT Bug: FLNK ignores PP or MS, although CA is allowed

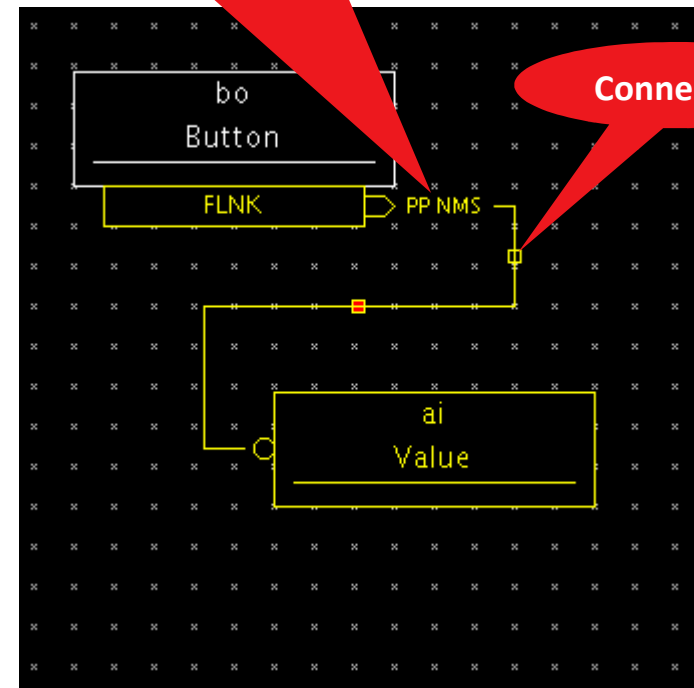

Using Macros

- Some screen-shots on previous slides used macros in the PV name
 - `$(user) :cathodeCurrentC`
- Macros can also be used in field values
 - Even in menu fields, just type into the box (expect vdct warnings though)
- Macros must be given values before/as the IOC loads the database
 - `$ msi -olinac-anj.db -Muser=anj linac.db`
 - `epics> dbLoadRecords linac.db user=anj`
 - `$ msi -olinac-anj.db -Slinac.substitutions`
 - `epics> dbLoadTemplates linac.substitutions`
- Macros are also used in hierarchical database designs
 - A database file that instantiates lower-level templates can provide values for macros used in those templates
 - A macro with a `.` in the name like `$(a.b)` is a reference to port `b` of an instance of the lower-level template named `a`

Hierarchical Example

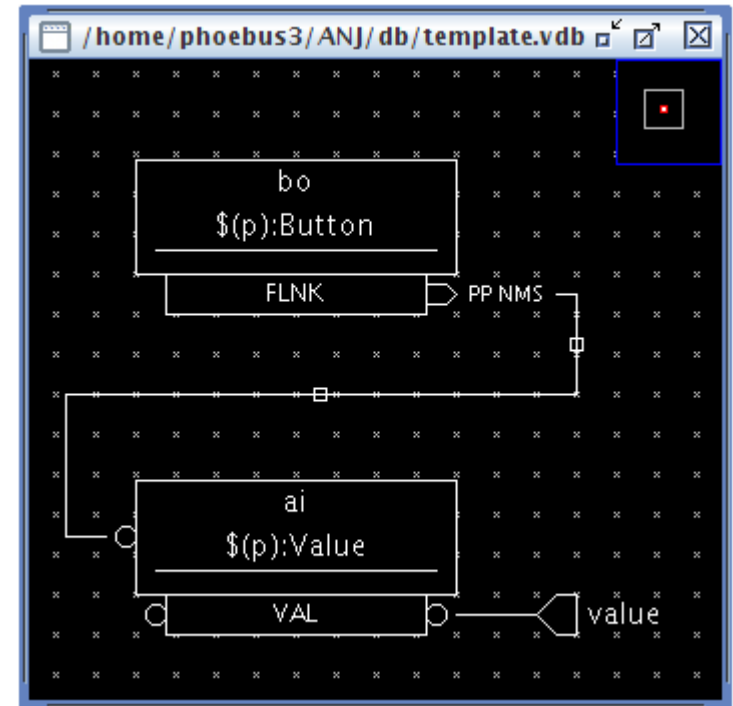
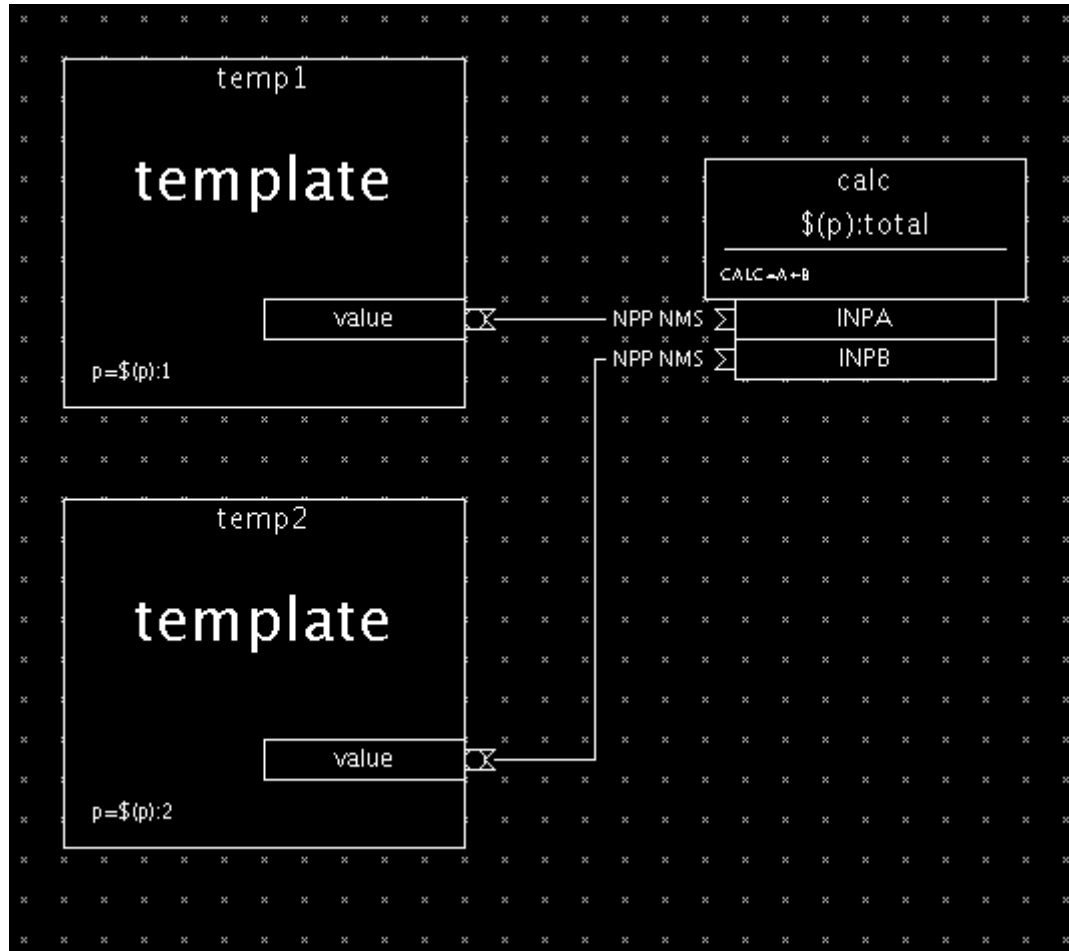

The template shown above has been instantiated twice, with different values for the macro p

Generated Database File

```
#! Generated by VisualDCT v2.6

# expand("/home/phoebus3/ANJ/db/template.vdb", temp1)
record(bo, "$(p):1:Button") {
  field(FLNK, "$(p):1:Value")
}

record(ai, "$(p):1:Value") {
}
# end(temp1)

# expand("/home/phoebus3/ANJ/db/template.vdb", temp2)
record(bo, "$(p):2:Button") {
  field(FLNK, "$(p):2:Value")
}

record(ai, "$(p):2:Value") {
}
# end(temp2)

record(calc, "$(p):total") {
  field(CALC, "A+B")
  field(INPA, "$(p):1:Value")
  field(INPB, "$(p):2:Value")
}
```

Template Symbol

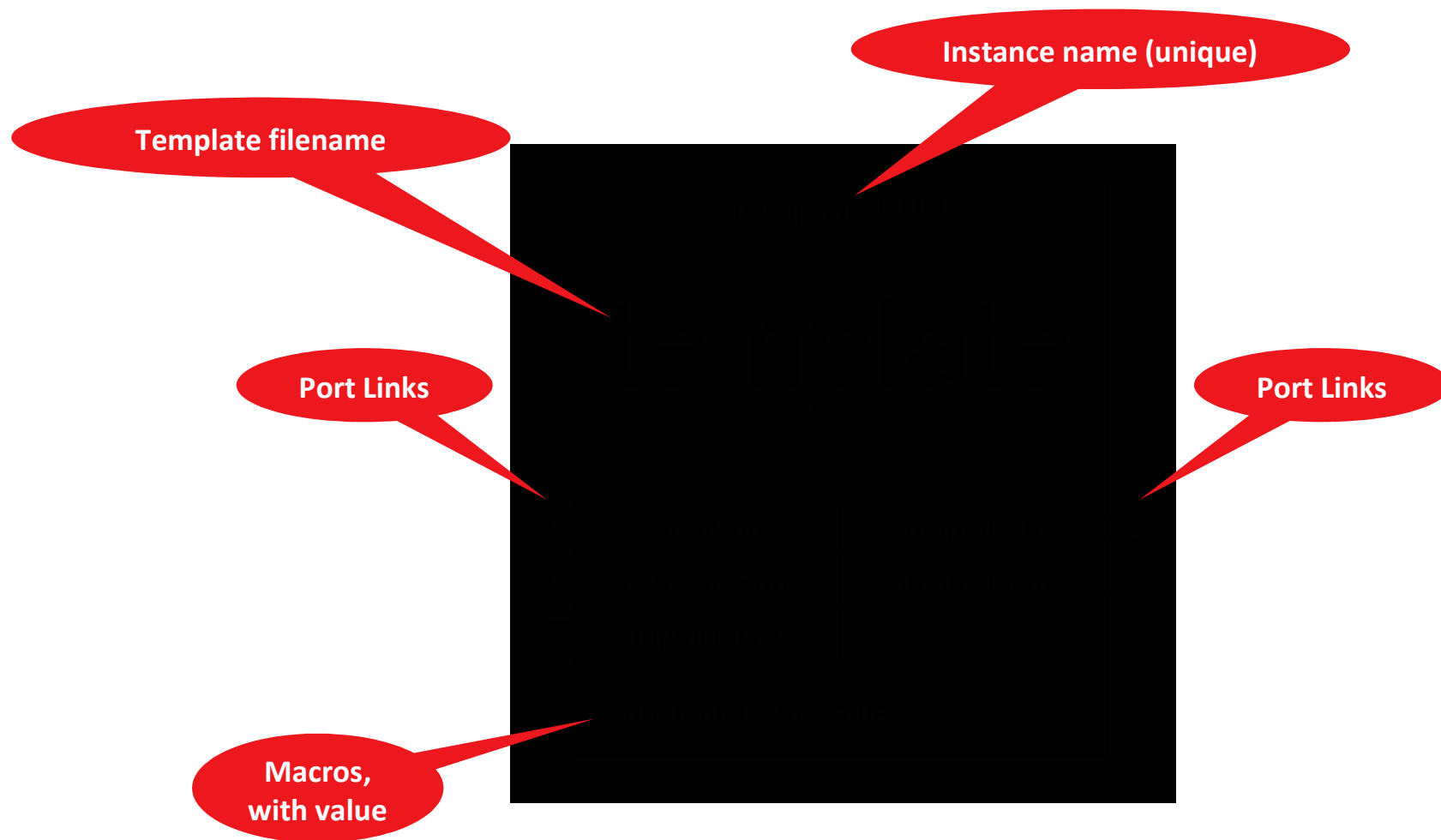

Working with Templates

- Create the template database and save it (important!)
- After saving, the work-space right-click menu shows new choices
 - Use 'Create port...' to add any ports to the template
 - Attach a port to any field that a record outside the template must link to
 - Use 'Create macro...' to add macro links
 - When you instantiate the template, port and macro links appear in the template symbol
- To instantiate template, first load it using 'File :: Import template...'
 - The imported template is now available on the work-space right-click menu under 'New template instance'
 - Double-click on the template box to bring up its inspector
 - To add new macros to the instance, right-click on the words 'Add macro...'
 - When you re-save a modified template file, the parent diagram updates automatically
 - Templates may contain instances of other templates
- Use 'File :: Generate...' to convert the top-level diagram to a flat-file .db file

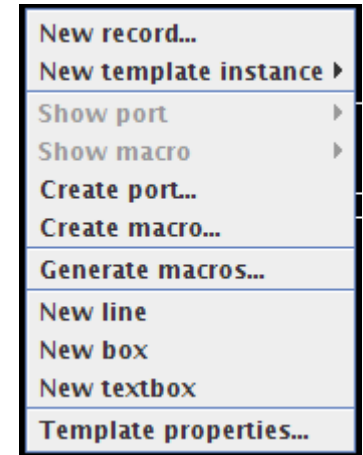

More Information

- EPICS Website :: Extensions web-page
 - VisualDCT Wiki page is linked under 'IOC Database Management Tools'
 - Links to downloads and documentation under "Where to find it"
- User's Manual covers most things
 - Templates and hierarchy's have a short separate manual
- Worth considering TDCT as well, although not as widely used
 - Lets you design your own template and record-type symbols